

Article number: 439500480

Description: Rota-fix shaft-hub connection F480x575  
Steel

Note: Self centering. Very high torque

## Measures

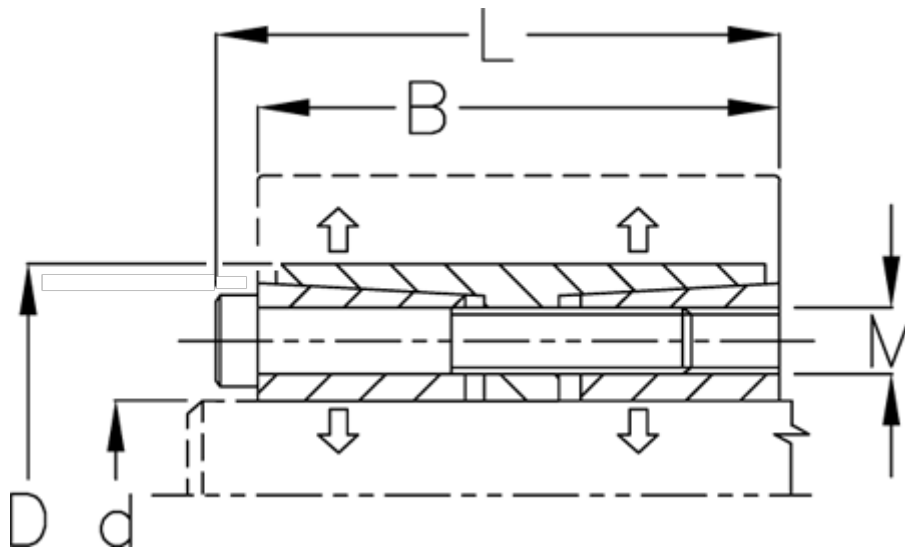

B mm	= 202
d H8 mm	= 480
D mm	= 575
Fit tolerance	= Aksel h8, Nav H8
F kN torque	= 4167.0
L mm	= 224
M mm	= M22
P N/mm <sup>2</sup> surface pressure on shaft/hub	= 106

Surface roughness	= R? ? 3.2 µm
T N m torque	= 999999
Ts N m bolt tightening torque	= 930.0